

TOP[®]
R/C HOBBY

AGE 14+

Lightning 2100
With Removable Middle Wing

Radio Control Model Airplane

Operation Manual



CONTENTS

Brief introduction.....	1
Main specifications.....	1
Main configuration.....	1
Products constitution.....	1
Assemble processes.....	2
Adjustment steps.....	3
Safety precautions.....	4
Charging method and cautions.....	4
Caution and Notice for Li-po battery	5
Caution and notice for ESC	5
Trouble shooting.....	6
Spare parts.....	7

Statement:

- 1.Please read this manual carefully and follow the instruction of the manual before you use this products;
- 2.Our airplane is not a toy, which is only suitable for the experienced manipulator or under the guidance of the experienced pilot.
3. Not recommended for the children under 14 years old.
- 4.Please adjust this plane according to the instruction and make sure that the finger and other parts of your body be out of the rotating parts of the plane, or it may cause damage to the plane or injury to your body.
- 5.Do not fly in the thunderstorm, strong wind or bad weather.
- 6.Never fly the plane where there are power lines overhead, automobiles, near airdrome , railway or highway.
- 7.Never fly our plane where are crowds of people .Give yourself plenty of room flying, as the plane can fly at a high speed. Remember that you are responsible for others safety.
- 8.Do not attempt to catch the plane when you are flying it.
- 9.The user should bear full responsibility of proper operation and usage with regards to this model. We, Top RC together with any distributor of us will not be responsible for any liability or loss due to improper operation.

Brief Introduction

Thanks for your purchasing our Lightning 2100 aircraft from Top RC Hobby, hope this aircraft will bring the endless joy to you.

★ Lightning 2100 is very easy to assemble in several minutes and the wings are removable, very easy to carry and maintain.

★ Embedded carbon spars and strips in fuselage and wings, makes the Lightning 2100 with high strength and make sure of the plane won't be twisted during the high speed flights.

★ Configured with left wing, right wing and middle wing, Lightning 2100 can be easily switched to the smaller size Lightning 1500 if you take out the middle wing, one model you buy it but enjoy two different flight experiences.

★ With 10 inch foldable propeller, makes the flight with a high efficiency and protects it from the damage of the landing.

★ Very nice appearances with good proportions, impressing people with a very good visual impact.

★ Very stable flight and flexible performances, easy to control, can realize the roll and high speed flights.

★ Full-moving tail, very easy to control.

★ With perfect design of the heat dissipation holes on the body, the motor, ESC and battery could be cooled fully during the high-speed flying, which makes our flight very safe.

★ Under the protection of landing skid and spoilers, Lightning 2100 can land from the ground without any damages for the foam parts.

★ Unique hidden pushrod design (elevator & rudder pushrods are hidden in the foams) makes the model more simple and nice.

Main Specifications

★ Wingspan: 2100mm

★ Length: 1016mm

★ Weight: 1320g

★ Thrust: $\geq 915g$

★ Flight time: $\geq 15min$

Main configuration

★ Motor: C2415-1150KV

★ ESC: 40A

★ Servo: 9g (plastic gear)*3+9g (metal gear)*1

★ R/C System: 2.4GHz 4Ch /optional

★ Battery: 11.1V 2200mAh 20C/optional

Product Constitution

RTF version

Fuselage, Main wings, Horizontal wing, Connecting Rod for Horizontal Wings, Connecting rod for Main Wings, Radio set, Charger, Battery, Accessories Bag.



ARF version

Kits without radio

PNP version

Kits without radio, charger and battery

KIT version

Without any electronic parts

Assemble processes

1. Please take out the left, right and middle wing, wing connecting rod, accessory bag. Insert the connecting rod to the middle wing, then connect the left and right wings to the middle wing. Connect the female plug from the middle wing to the servo cables, then fix the wings with nylon screws.

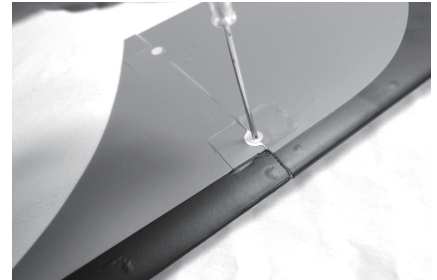
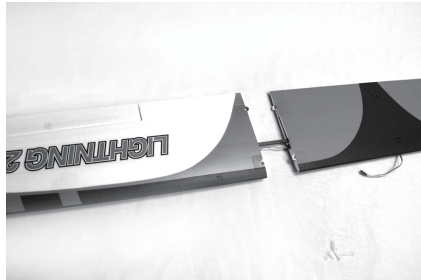

2. Please take out the fuselage and horizontal wing, short wing connecting rod. Insert the short wing connecting rod into the assembly holes from the rudder, then make the connecting rod insert into the left and right horizontal wings. Fix the wings with screw.

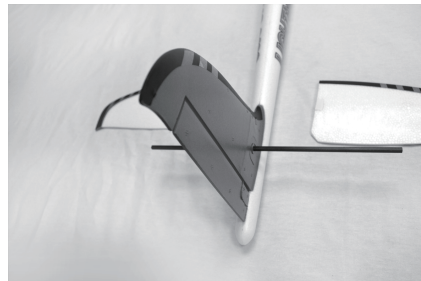
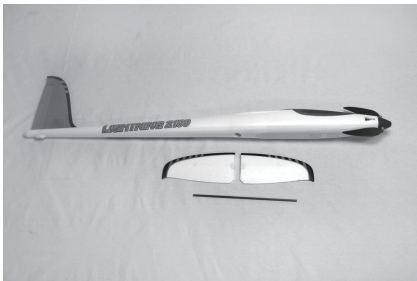

3. Put the assembled main wings to the right position on the top of the fuselage, fix well the wings with screws to the fuselage.

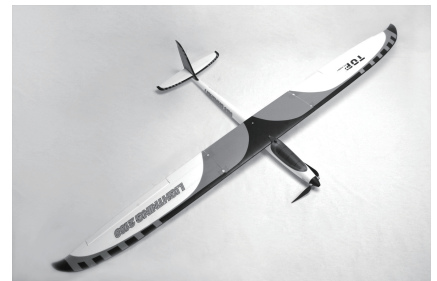
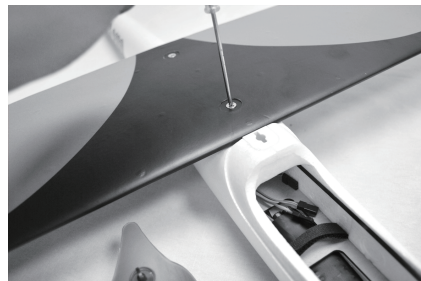
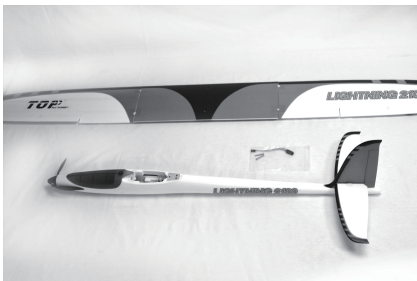

4. Close the canopy, then the assembly finished.

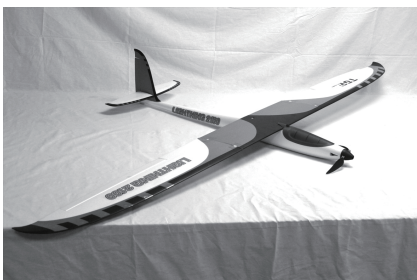

Adjustment steps

1. Turn on the transmitter and please make sure that there is enough power for the transmitter. Push the joystick of the throttle and throttle trim switch to the lowest position, and keep other trim switch be in the neutral position.



2. Please connect the battery to the ESC plug, and put the battery into the battery case well, then close the battery cover.

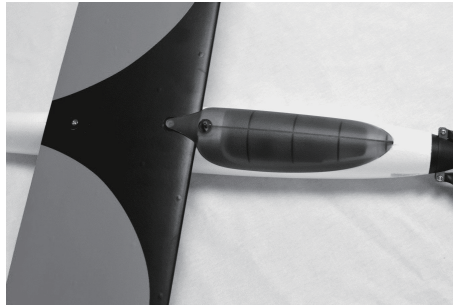
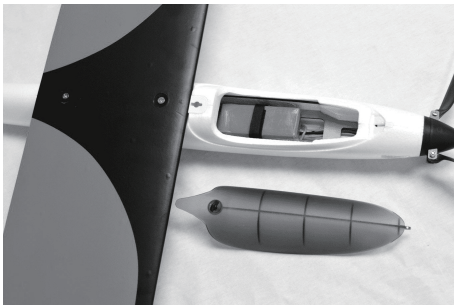

3. Please catch the back part of the fuselage and push the throttle slowly, which can check whether the motor can work or not.



4. Please check the collets to confirm whether it become loose or not, and make sure that the control surface is in accordance with the movement of joystick.



Adjustment steps

5. Check the center of gravity and make sure that the CG of the plane should be within the range as indicated by the arrows.

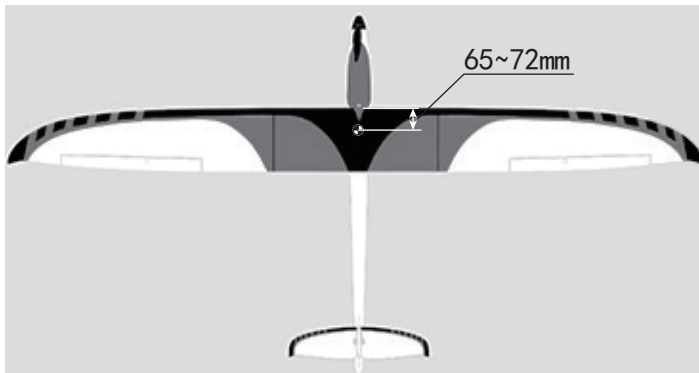

6. Finished the adjustment for "GS2100".

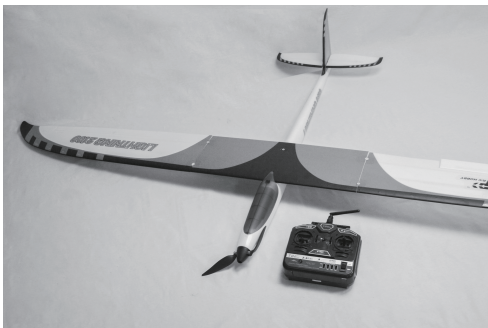

Safety precautions

1. If you have the simulator, we suggest that you can practise your skill by the simulator before you fly this model, which will bring some help for you.
2. Please climb the plane above the 50 meters with half throttle to fly it when you fly it for your first time, then you will be familiar with the performance of this plane.
3. You should learn how to control this model blandly, it will reduce the possibility of crash and prolong the usage life of the plane.
4. The turn radius should not be too little, or it will stall and it will increase the possibility of crash.
5. When taking off or landing the plane, you should against the wind.
6. Do not fly the model over your head or behind you, you should fly the model in front of you.

Charging method and cautions

Li-Po battery(balance changer) specifications

Specifications:

Input voltage: DC 10V~15V

Output voltage: 2S-3S Li-Po battery

Charging current: 1.0A

Indicator state:

Green: Charge complete & no battery

Red: Charging

The batteries are inspected separately. When the voltage reaches 4.20V, the charging process stops.



Operating

1. Then plug cigarette into its socket in car (Adapter should be connected if charge at home: connect the adapter to home power socket, then plug the adapter' DC end to charger). The LED will turn green indicating it is ready for charging.
2. Connect the battery to charger per its interface mark. The LED becomes red, which means charging is on the way.
3. When LED flashing, the charger will enter the stage of drip current charging. The LED turns green when fully charged, and the battery will be used at any time.



Notice

1. While charging is in process, please do not make it near flammable materials.
2. Expect Li poly battery, this charger is not allowed for other kinds of battery.
3. While charging, please keep it out of the reach of Children.
4. When this charger is in use, please do not go away and leave it unwatched, if any abnormality occurs (such as the power indicator is off, the temperature of the battery rise rapidly, etc.) stop charging immediately.
5. Please do not use power with output voltage higher than 15V.
6. Please do not disassemble the charger or its accessories.
7. When the battery is not cool down, please do not urge to charge it.

Notice

1. Be fully charged under no more than 1 A voltage by using the specified charger.
2. Be discharged under 10C voltage but avoiding discharge time too long to harm the battery.
3. Repeat the first and second step one or two times.
4. When the Li-poly battery was stored more than 3 months, it needs to be recharged to maintain its voltage, and ensure its life time.

Safety Instruction of Li-Po/Ni-MH battery

1. Do not disassemble or reconstruct the battery.
2. Do not short-circuit the battery.
3. Do not use or leave the battery nearby the fire, stove or heated place (more than 80°C).
4. Do not immerse the battery in water or sea water, do not get it wet.
5. Do not charge the battery under the blazing sunlight.
6. Do not drive a nail into the battery, strike it by hammer or tread it.
7. Do not impact or toss the battery.
8. Do not use the battery with conspicuous damage or deformation.
9. Do not charge a warm battery. Allow it to cool completely before attempting to charge.
10. Do not reverse charge or over discharge the battery.
11. Do not connect the battery to the ordinary charger socket or car cigarette jack.
12. Do not use the battery for unspecified equipment.
13. Do not touch the leaking battery directly, please wash your skin or clothes with water if they are bedewed by liquid leaking from the battery.
14. Do not mix the Li-Poly battery with other un-chargeable battery in using.
15. Do not continue charging the battery over the prescribed time.
16. Do not put the battery into the microwave oven or high-pressure container.
17. Do not use the abnormal battery.
18. Do not use or keep the battery under the sunlight.
19. Do not use the battery nearby the place where generates static electricity (over 64V).
20. Do not charge the battery when the environmental temperature is under 0°C or over 45°C.
21. If you find the battery leaking, smelling or abnormal, stop using it and return it to the seller.
22. When the battery is charging, please do not make it near the flammable materials!
23. Keep the battery away from the children.
24. Use the specified charger and observe charging requirement (under 1A).
25. When using by minors, parents should show them to the correct instruction.

Trouble shooting

Problem	Possible Cause	Solution
Aircraft will not respond to the throttlebut responds to other controls.	<ul style="list-style-type: none"> -ESC is not armed. -Throttle channel is reversed. 	<ul style="list-style-type: none"> -Lower throttle stick and throttle trim to lowest settings. -Reverse throttle channel on transmitter.
Extra propeller noise or extra vibration.	<ul style="list-style-type: none"> -Damaged spinner, propeller, motor or motor mount. -Loose propeller and spinner parts. -Propellor installed backwards. 	<ul style="list-style-type: none"> -Replace damaged parts. -Tighten parts for propeller adapter, propeller and spinner. -Remove and install propeller correctly.
Reduced flight time or aircraft underpowered.	<ul style="list-style-type: none"> -Flight battery charge is low. -propeller installed backward. -Flight battery damaged. 	<ul style="list-style-type: none"> -Completely recharge flight battery. -Replace flight battery and follow flight battery instructions.
Control surface does not move, or is slow to respond to control inputs.	<ul style="list-style-type: none"> -Control surface, control horn, linkage or servo damage. -Wire damaged or connections loose. 	<ul style="list-style-type: none"> -Replace or repair damaged parts and adjust controls. -Do a check of connections for loose wiring.
Controls reversed.	Channels are reversed in the transmitter.	Do the control direction test and adjust controls for aircraft and transmitter.
<ul style="list-style-type: none"> -Motor loses power -Motor power pulses then motor loses power. 	<ul style="list-style-type: none"> -Damage to motor, or battery. -Loss of power to aircraft. -ESC uses default soft Low Voltage Cutoff(LVC). 	<ul style="list-style-type: none"> -Do a check of batteries, transmitter, receiver, ESC, motor and wiring for damage(replace as needed). -Land aircraft immediately and recharge flight battery.
LED on receiver flashes slowly.	Power loss to receiver.	<ul style="list-style-type: none"> -Check connection from ESC to receiver. -Check servos for damage. -Check linkages for binding.

Trouble shooting guide

Strict ground inspections must be done before each flight, which can effectively avoid flight accidents.

1. Check if the screws of the whole airplane are installed in place or not, the servo arms and horns are connected reliable or not and wings fixing are locked or not.
2. Install the battery and adjust the aircraft's center of gravity to the recommended position in the manual.
3. Make sure power battery, remote control transmitter battery, etc. are fully charged and in a reliable working condition.
4. Gently push the throttle to check if the propeller is turning correctly or not.
5. After all checks are completed, the flight can be started. The first flight for beginners needs the assistance of experienced enthusiasts to avoid flight accidents due to improper operation.

About flight time

The recommended flight time by the manufacturer is using the battery what we request, and the flight test is completed by experienced enthusiasts on a breeze day. This flight time is related to battery parameters, aircraft weight, flight conditions and flight methods. Different conditions may result in different flight times.

It is recommended that enthusiasts use the "timing function" of the remote control during flight. It is recommended that the initial flight time be set within 4 minutes.

When there is a countdown alarm, please land the aircraft and measure the battery voltage. At the end of the battery discharge period, it is forbidden to fly the aircraft into the leeward zone (the far end of the wind direction) to prevent the aircraft from being unable to return safely due to insufficient power.

Spare part for Lightning2100



No: TOP09001
Fuselage



No: TOP09002
Main wings



No: TOP09003
Horizontal wings

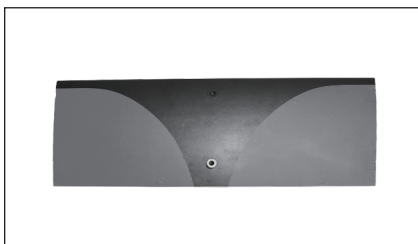

No: TOP09004
Middle Wing



No: TOP09005
Canopy

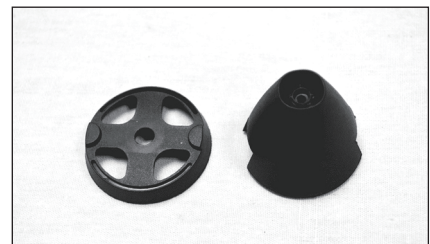

No: TOP09006
Spinner

Spare part for Lightning2100

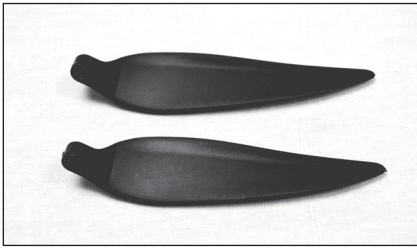

No: TOP03506
10*7inch Propeller

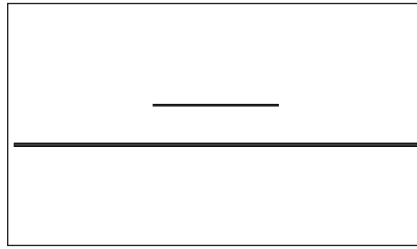

No: TOP03507
Connecting rod

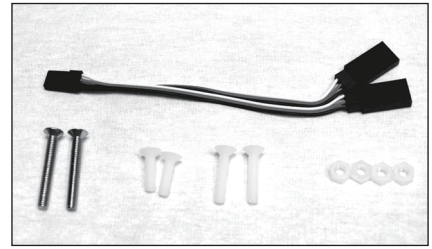

No: TOP03508
Spare parts bag

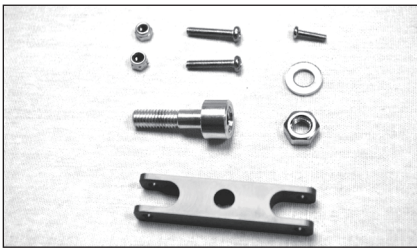

No: TOP03509
Adapter for propeller

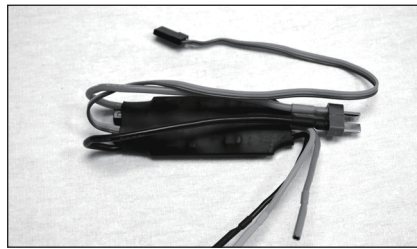

No: TOP20401
40A Brushless ESC
(with brake function)



No: TOP30201
9g servo(plastic gear,wire:400mm)
for Aileron



No: TOP30204
9g servo(plastic gear,wire:150mm)
for Rudder

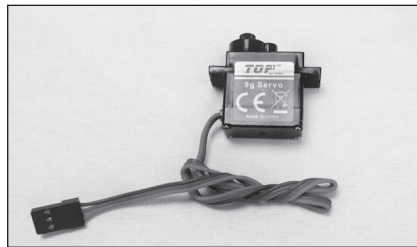

No: TOP30208
9g servo(metal gear 150mm)
for Lightning Elevator

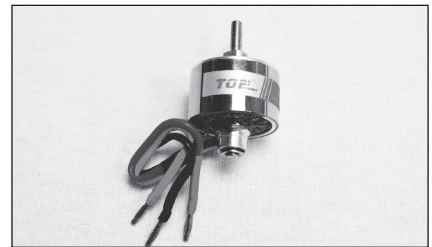

No: TOP40602
Out runner brushless
C2415-1150KV (3S version)

Lightning 2100

With Removable Middle Wing

Radio Control Model Airplane

TOP[®]
R/C HOBBY

Shenzhen Top RC Hobby Tech Co.,Ltd

www.toprchobby.com

Tel: 0086-(0)755-27908315

Fax: 0086-(0)755-27908325

AGE 14+



FC

Made in China