

User Manual

E150



SCHEUFER Technologies GmbH
Address:Hertleinstrasse 37,91052,Erlangen,Germany
E-mail:Mark.Zhang@scheufer.com



VISHTEC UK Co.,Ltd
Address:Unit G25 Waterfront Studios,1DockRoad,London,E16 1AH
E-mail:Vincent.feng@vish-tec.com



MADE IN CHINA



Content	Page
Introduction	1
Contents List	1
Notice	2
Warning	2
Additional Safety Precautions and Warnings	2
Helicopter Specifications	3
Warning and Guidance of Battery Usage	3
Battery Charging	3
Notice Before Flight	4
Pairing With Transmitter	4
Throttle Curve and Pitch Curve	5
Initial Flight Setup	6
Flight Control Board Interface Diagram	6
About the Transmitter	7
Flight Control Board Adjustment	8
Troubleshooting	9
Illustrated Parts Diagram	10
Illustrated Parts List	11
Spare Parts List	12

Introduction

This is a premium mini 3D helicopter with excellent flight performance. The DFC direct linkage design reduces the resistance and slop in the rotor head mechanism. With improved aerodynamics, the blades deliver outstanding power and stability. The state of the art Flight Control Board utilises the latest technological improvements and provides 3D and 6G modes. Extreme aerobatic stunts are possible in 3D mode. 6G mode is especially suitable for beginners.

Once you have flown this mini helicopter, you will appreciate its high quality of build and features are a quantum leap ahead of other similar mini helicopters in the market. When the heli has been set up correctly, beginners will find it very easy to fly. They can quickly learn and master new moves. The built-in 'rescue' function in 6G mode can save the helicopter in situations of pilot disorientation or momentary loss of composure.

The detailed instructions in this manual will help you understand more about the product. Please read it before operating your helicopter. It may help you to save both time and money due to incorrect settings etc.

Contents List

NO.	PARTS	QUANTITY
1	Gift Box	1
2	Sturdy PVC protective box	1
3	User Manual	1
4	Helicopter	1
5	Transmitter	1
6	Charger	1
7	Battery 11.1v 500mah 30C	1
8	Cross Screwdriver / Hex Wrench	1
9	Main Blade	2
10	Tail Blade	1

Notice

All instructions, warranties and other collateral documents are subject to change at the sole discretion of our company. For up-to-date product literature, please visit www.eachine.com.

Warning

Read the ENTIRE user manual to become familiar with the features of the product before operating. Failure to operate the product correctly can result in damage to the product, personal property and cause serious injury. This is a sophisticated hobby product. It must be operated with caution and common sense and requires some basic mechanical ability. Failure to operate this product in a safe and responsible manner could result in injury or damage to the product or other properties. This product is not intended for use by children without direct adult supervision. This manual contains instructions for safety, operation and maintenance. It is essential to read and follow all the instructions and warnings in the manual prior to assembly, setup or use in order to operate correctly and avoid damage or serious injury.

Additional Safety Precautions and Warnings

1. Age Recommendation: Not for children under 14 years. This is not a toy.
2. Always operate your model in open spaces away from full-size vehicles, traffic and people.
3. Follow the operation notice, warning and any support equipment (charger, battery, etc) instruction carefully.
4. Keep away from any chemicals. Keep children away from any small parts and electrical equipment.
5. Always keep away from water. This product and its electronics are not water- proof. Components can be damaged by moisture.
6. Never place any portion of the model in your mouth as it could cause serious injury or even death.
7. Never operate your model when the transmitter batteries are low voltage .

Helicopter Specifications

Length	330 mm
Height	105mm
Weight	181g
Length of Main Rotor	355 mm
Diameter of Tail Rotor	56mm
Battery Specification	11.1v 500mAh 30C
Flight Time	7-9 Min
Brushless Main Motor	2507
Brushless Tail Motor	1103

Warning and Guidance on Battery Usage



WARNING: It is highly recommended to use the supplied charger to charge the battery.

Notice: When the battery voltage is lower than 11.1V, the lithium battery may be damaged, and may no longer be correctly charged. When the battery voltage is lower than 11.1V during a flight, the main ESC drops the head speed significantly. Please land immediately and charge the battery as soon as possible.

Battery Charging

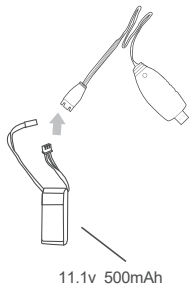

1. To charge the battery, please connect the charger USB plug into a USB power bank or to a USB port of a computer or a power adaptor. If no battery is connected, the USB charger red light will flash.
2. Once the battery is plugged into the USB charger, the charger's red light is lit to indicate the charging is in progress.
3. When the battery is fully charged, the USB red light will stay off.

Warning

1. For maximum safety, please monitor the battery while charging.
2. Please do not allow children to carry out the charging by themselves but ensure adult supervision is available at all times.
3. Please use the original standard charger of this product for charging. The use of unknown charger may pose risks of fire and explosion.
4. If available, it is recommended that users use a quality Lipo charger (3s @2A) in lieu of using the USB charger. This helps to charge the battery at a faster rate.

Notice Before Flight

1. Ensure the batteries for both the TX and helicopter are fully charged.
2. Before turning on the TX, please make sure the throttle control is at the lowest position and the TH.HOLD and 3D mode switches are in the back position (back cover direction).
3. Make sure the TX has paired with the helicopter. If not or please carry out the pairing process.
4. Please turn on the TX first, then connect the battery to the helicopter and wait until it is paired with the TX. When switching off, please unplug the power from the helicopter first and then turn off the TX.
5. Keep away from people, cars, high-tension power lines and water sources such as ponds, lakes, rivers etc.

Pairing With Transmitter

If you have the RTF package, the helicopter is already paired at the factory. However, if you need to pair again, please follow the following steps.

1. First turn on the transmitter and make sure the throttle stick is at the bottom position and 3D IDLE switch is in the OFF position.
2. Remove the canopy for access.
3. Apply power to the helicopter, the red led flashes slowly. Press the bind button for 1 second, then the red lamp will go out and get ready for pairing.
4. When the red and blue lights turn on solid, the pairing is successful.
5. While carrying out the pairing, ensure there are no other transmitters are operating nearby to avoid unintended pairing.

Tips: This product is compatible with all FUTABA 2.4GHZ S-FHSS transmitter.

Notice :

1. When the transmitter is turned on and the throttle hold switch is in the ON position, the transmitter will beep as a warning. The switch should be switched to the OFF position.
2. When the transmitter is turned on and the 3D switch is in the ON position, the transmitter will beep. The switch should be switched to the OFF position.
3. When transmitter is turned on and the throttle stick is not at the lowest position the transmitter will beep as a warning. The throttle stick should then be moved down to the lowest position.

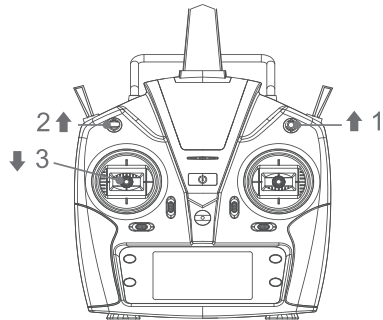

Throttle Curve and Pitch Curve

Throttle Curve	Position	Normal	3D Idle
	1	0	85
	2	70	85
	3	70	85
	4	70	85
	5	70	85

Pitch Curve	Position	Normal	3D Idle
	1	35	15
	2	45	32
	3	50	50
	4	65	68
	5	80	85

The above information is for guidance only. You can set the parameters to your personal preference.

Initial Flight Setup

If you are not familiar with the controls of the E150, please take a few minutes to get familiar with them and then try your first flight.

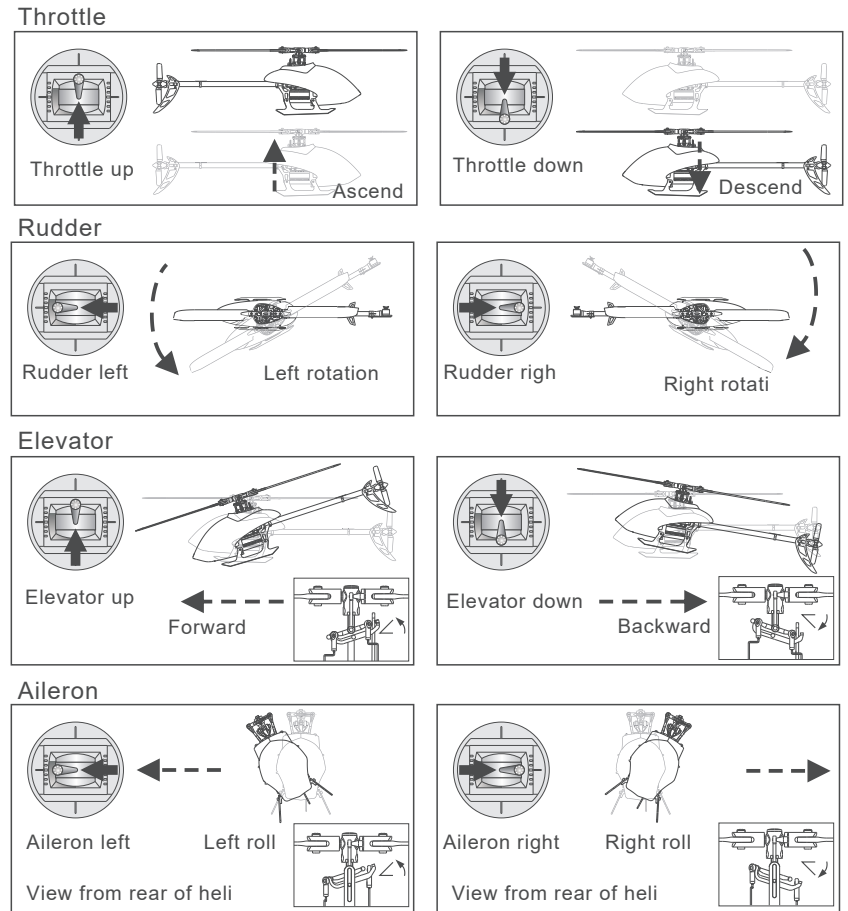

Flight Control Board Interface Diagram

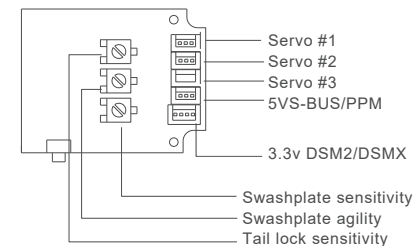

Notes: 3.3V is suitable for DSM receiver and 5V is suitable for FUTABA (S-BUS) J receiver.

About the Transmitter

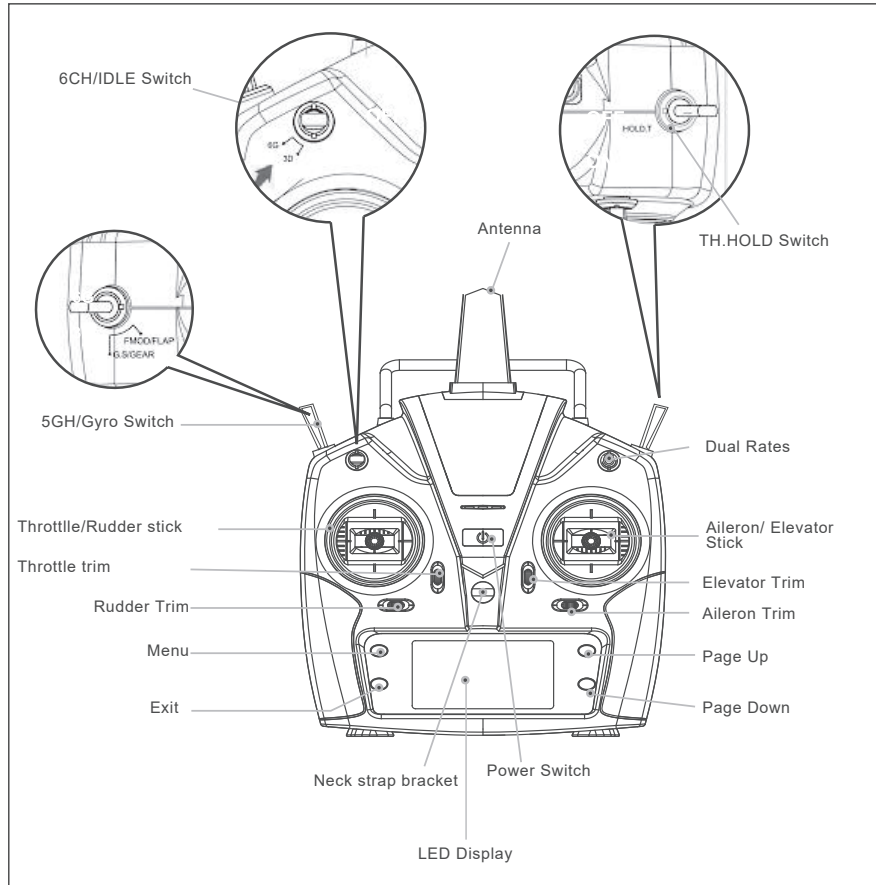

Right hand throttle

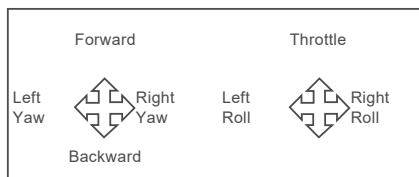

Left hand throttle

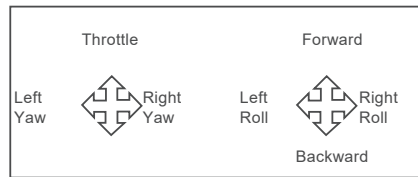

This transmitter supports CCPM 120 degree helicopter mode with 3D 6G switching. It has high/low rates for two joystick modes, motor cutout switch (TH.HOLD) and a large screen multi-function LCD display.

Flight Control Board Adjustment

1) Servo Centering Adjustment

Note: The product has been adjusted and inspected before leaving the factory. The user needs to re-adjust the servo centering after replacing the servo or related accessories.

To ensure safety, disconnect the main motor power during adjustment to avoid personal injury caused by motor rotation.

If you have one, a swashplate levelling tool allows more accurate adjustment.

First, bind the heli and set the transmitter to 6G self-stabilization mode.

Press the bind button on the flight control board 4 times, the mainboard will flash red quickly and enter the adjustment mode.

Use the transmitter sticks to adjust the aileron, elevator and rudder servos until the swashplate is balanced and the blades are at 0 degrees pitch.

After the servo adjustment is completed, press the mainboard bind button to exit.

The red and blue light on the mainboard will be lit.

You can now fly.

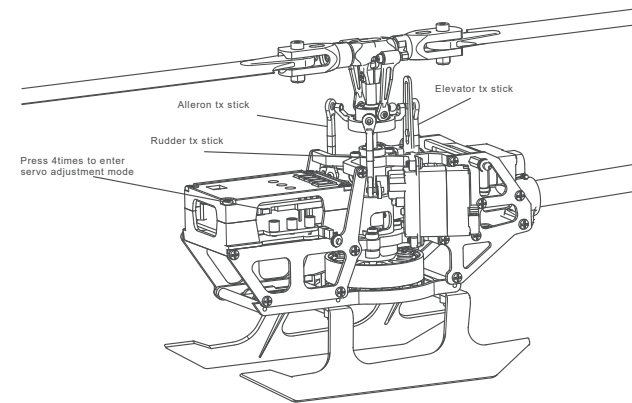

2) Gyro adjustment

Users can adjust the FBL gyro according to their preference. Use a flat-blade screwdriver to adjust. Turn clockwise to increase the value, and turn counterclockwise to decrease the value.

1 Tail lock sensitivity 2 Swashplate agility 3 Swashplate sensitivity.

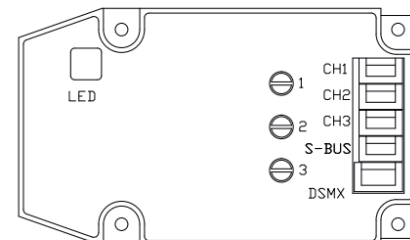

Troubleshooting

	Problem	Cause	Solution
1	LED on receiver flashes constantly with no response after transmitter is switched on.	Transmitter is not bound to receiver. Pairing of the transmitter and receiver failed.	Carry out pairing (Refer to P.5, Pairing to Transmitter).
2	The helicopter has no response after connecting the battery.	Check whether the transmitter and receiver are connected to power. Check the voltage of transmitter and receiver batteries. Heli battery connector pins contacts are degraded.	Open the transmitter, make sure the batteries connection is good. Replace and charge transmitter batteries. Make sure the heli battery connector pins contacts are good.
3	When increasing throttle, the main motor does not start and the LED on the receiver flashes continuously.	Low battery voltage, battery connection is not good.	Replace and charge the battery, reconnect the battery to the receiver board.
4	Helicopter takes off immediately, after powering up.	The throttle is not at the lowest position.	Put the throttle stick at the lowest position before switching on the transmitter.
5	Helicopter vibrates or shakes in flight.	Damaged rotor blades, bent main shaft and feathering shaft or blade grips too tight preventing smooth movement of the main rotor.	Replace the main rotor blades, bent main or feathering shafts, loosen the blade grips.
6	Main rotor blades shake during flight.	Feathering shaft or main shaft is bent. FS screw is not tight enough. Broken gear in the servo. The swashplate is worn out.	Replace the feathering shaft. Tighten the FS screw. Change the main shaft bearings. Replace the servo. Replace the swashplate. Replace the tail rotor blades.
7	The sound of the main rotor becomes softer or there is drop in head speed.	Heli battery has low voltage.	Land the helicopter immediately and charge the battery or change to a fully charged battery.
8	Helicopter has no response or does not fly smoothly.	Failure of binding.	Rebind the helicopter and transmitter. Make sure you place the helicopter in a steady and level attitude close to the transmitter.
9	Helicopter drifts or is not level in 3D or 6G flight modes.	Servos do not go back in to mid-position or are broken.	Recenter the servo arms. Replace the applicable servo.
10	Tail does not lock in 6G mode.	Helicopter requires calibration in 6G mode.	Refer to 6G mode calibration procedure.
11	Helicopter yaws counter clockwise when taking off.	Tail motor lacks power. Loose tail rotor. Tail motor damage.	Check the tail rotor and the motor shaft. If loose, replace the tail rotor. Replace the tail motor.
12	Helicopter power is erratic or speed governor has abnormal sound.	Power Distribution Board is faulty or has poor contacts.	Check the connectors. Replace the Power Distribution Board.

Illustrated Parts Diagram

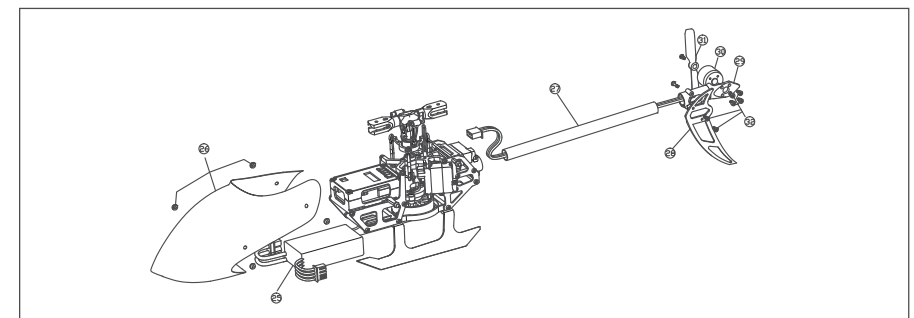
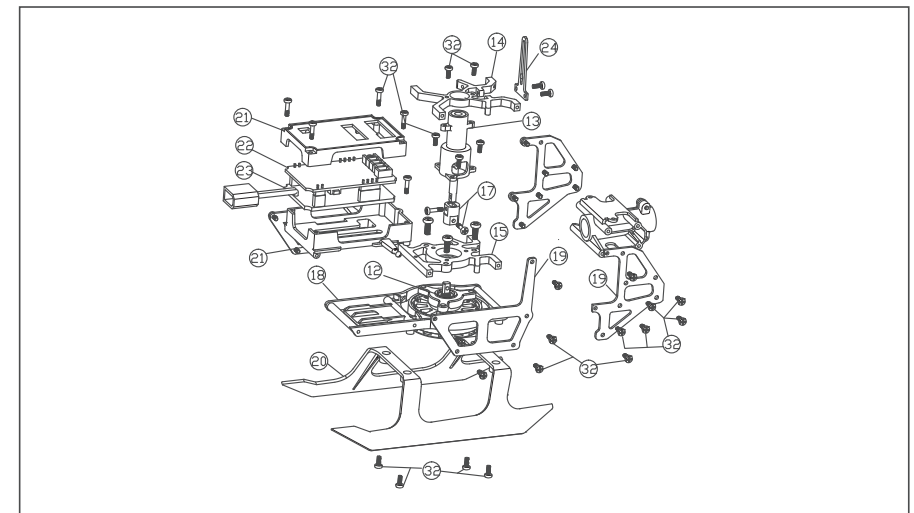
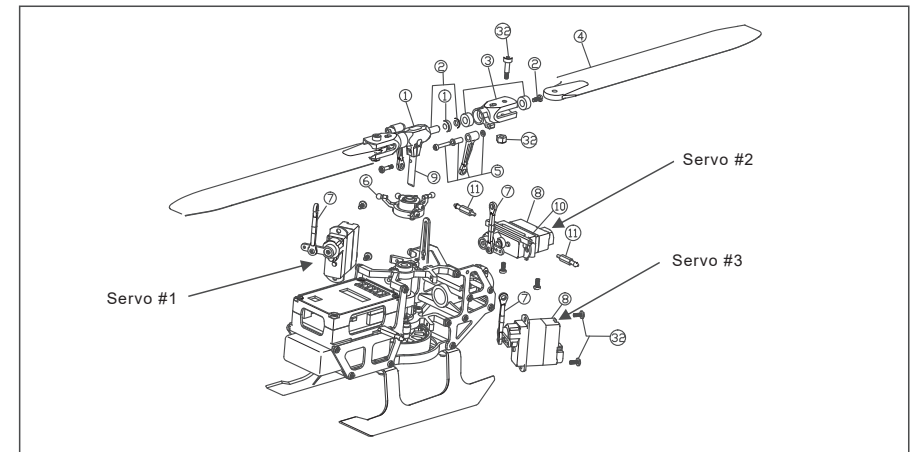



















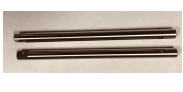













Illustrated Parts List

NO.	PART NAME	QUANTITY
1	Main Rotor Head	1
2	Main Grip Feathering Shaft Set	2
3	Main Blade Grip Set	2
4	Main Blade Set	2
5	Primary Linkage Set	2
6	Swashplate	1
7	Secondary Linkage Set	3
8	Servo	1
9	Main Shaft Set	2
10	Servo Mounting Plate	1
11	Canopy Mounting Posts	2
12	Main Motor	1
13	Main Shaft Bearing Mount	1
14	Metal Frame Plate A	1
15	Metal Frame Plate B	1
16	Tail Boom Mount	1
17	Main Shaft to Motor Connector	1
18	Landing frame Set	1
19	Carbon Fiber Side Frame Set	4
20	Landing Skid Set	1
21	Flight Control Unit Box	1
22	Integrated Flight Control Board	1
23	Power Distribution Board (PDB)	1
24	Anti Rotation Bracket	1
25	Battery	1
26	Canopy	1
27	Tail Boom	1
28	Tail Fin Set	1
29	Tail Motor Mount	1
30	Tail Motor	1
31	Tail Rotor	2
32	USB Charger	1
33	Radio Control	1

Notice for beginners:

1. Please fly with an instructor until you are confident enough.
2. Before flying the model for the first time, you need to fully understand all of the functions provided by the transmitter and the responses of all of the switches.
3. Do not attempt to fly in 3D mode yet. Practice hovering and flying in 6G mode until you are familiar with it. Then you can practice hovering and flying in 3D mode. Once you are familiar with these two modes you can progress to practicing inverted flight with an instructor.
4. Practicing inverted hovering and inverted flight will build a solid foundation towards achieving proficiency in 3D flying.
5. This model is not a toy and it can cause damage to people and property. It is recommended that you practice with a simulator on a computer before doing real 3D flying with this model to minimize damage.

Spare Parts List

Part No: 2.32.01.E150-001 Part Name: Main Rotor Head 	Part No: 2.32.01.E150-002 Part Name: Main Grip Feathering Shaft Set 	Part No: 2.32.01.E150-003 Part Name: Main Blade Grip Set 	Part No: 2.32.01.E150-004 Part Name: Main Blade Set 
Part No: 2.32.01.E150-005 Part Name: Primary Linkage Set 	Part No: 2.32.01.E150-006 Part Name: Swashplate 	Part No: 2.32.01.E150-007 Part Name: Secondary Linkage Set 	Part No: 2.32.01.E150-008 Part Name: Servo 
Part No: 2.32.01.E150-009 Part Name: Main Shaft Set 	Part No: 2.32.01.E150-010 Part Name: Servo Mounting Plate 	Part No: 2.32.01.E150-011 Part Name: Canopy Mounting Posts 	Part No: 2.32.01.E150-012 Part Name: Main Motor 
Part No: 2.32.01.E150-013 Part Name: Main Shaft Bearing Mount 	Part No: 2.32.01.E150-014 Part Name: Metal Frame Plate A 	Part No: 2.32.01.E150-015 Part Name: Metal Frame Plate B 	Part No: 2.32.01.E150-016 Part Name: Tail Boom Mount 
Part No: 2.32.01.E150-017 Part Name: Main Shaft to Motor Connector 	Part No: 2.32.01.E150-018 Part Name: Landing frame Set 	Part No: 2.32.01.E150-019 Part Name: Carbon Fiber Side Frame Set 	Part No: 2.32.01.E150-020 Part Name: Landing Skid Set 
Part No: 2.32.01.E150-21 Part Name: Flight Control Unit Box 	Part No: 2.32.01.E150-22 Part Name: Integrated Flight Control Board 	Part No: 2.32.01.E150-23 Part Name: Power Distribution Board (PDB) 	Part No: 2.32.01.E150-24 Part Name: Anti Rotation Bracket 
Part No: 2.32.01.E150-25 Part Name: Battery 	Part No: 2.32.01.E150-26 Part Name: Canopy 	Part No: 2.32.01.E150-27 Part Name: Tail Boom 	Part No: 2.32.01.E150-28 Part Name: Tail Fin Set 
Part No: 2.32.01.E150-29 Part Name: Tail Motor Mount 	Part No: 2.32.01.E150-30 Part Name: Tail Motor 	Part No: 2.32.01.E150-31 Part Name: Tail Rotor 	Part No: 1.03.04.001 Part Name: USB Charger 
Part No: 2.03.01.T6-001 Part Name: Transmitter 